

## Dictating and The NATO Phonetic Alphabet

Do you know the 26 letters of the English alphabet?

How well can you pronounce the individual letters?

Match the 26 letters of the alphabet with the correct phoneme, some have been done for you.

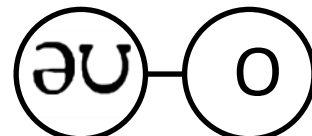
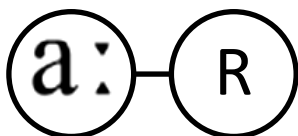
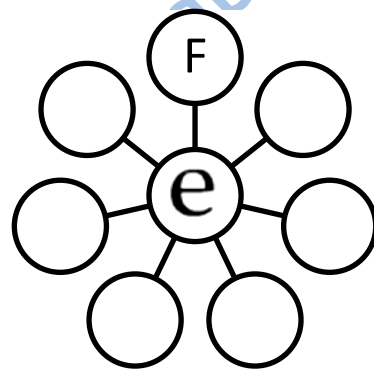
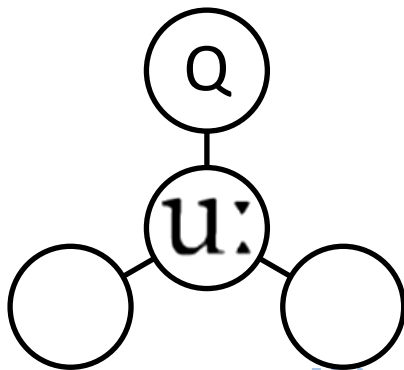
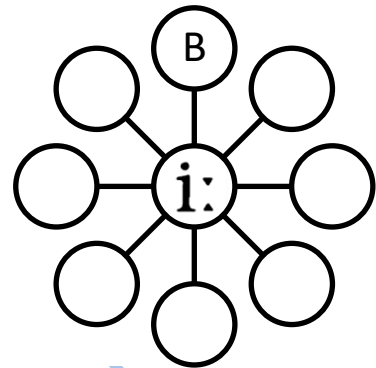
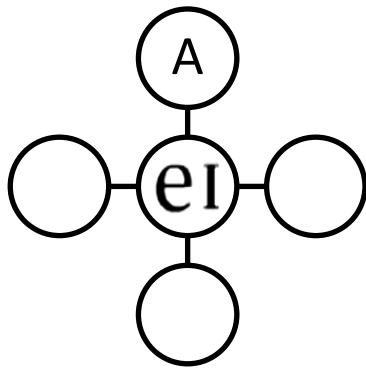

A, B, C, D, E, F, G, H, I, J, K, L, M, N, O, P, Q, R, S,  
T, U, V, W, X, Y, Z

### The NATO Phonetic Alphabet

The NATO alphabet is an internationally recognised alphabet designed to make dictating letters of the alphabet clear. The words representing the letters have been chosen as they are easily

recognised and not confused with similar words. Try to complete the alphabet using the 26 letters of the alphabet (clue: they are not in alphabetical order!):

__ango,	__ike,	__ovember,
__ankee,	__ilo,	__oxtro,
__apa,	__ima,	__ravo,
__cho,	__lpha,	__-ray,
__elta,	__ndia,	__scar,
__harlie,	__niform,	__uebec,
__hiskey,	__olf,	__uliet,
__ictor,	__omeo,	__ulu.
__ierra,	__otel,	

### A for Apple...

Another way to dictate letters clearly is to give a word which starts with the same letter. Names of cities, states and countries are common words used as reference. Can you spell out the names of the countries using only places within the countries?

B	for...	A	for...
R	for...	M	for...
I	for...	E	for...
T	for...	R	for...
A	for...	I	for...
I	for...	C	for...
N	for...	A	for...

Which do you think is easier: the NATO phonetic alphabet or the "A for apple" method?

## Answers

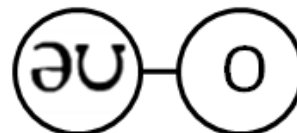
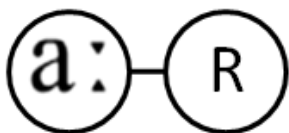
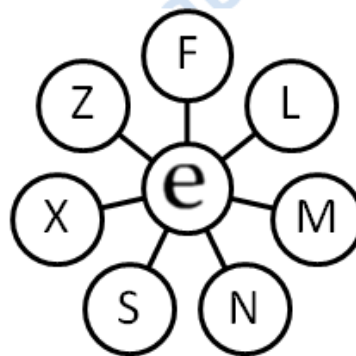
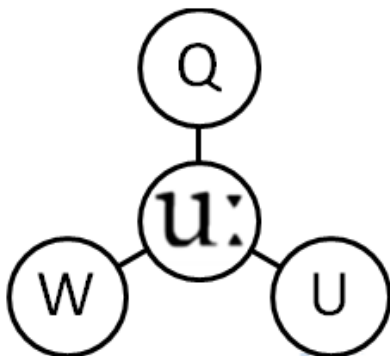
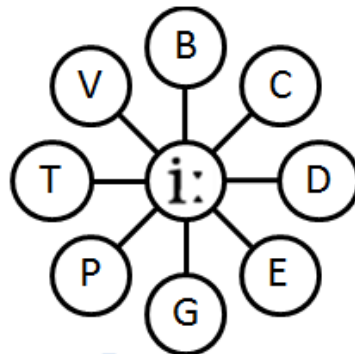
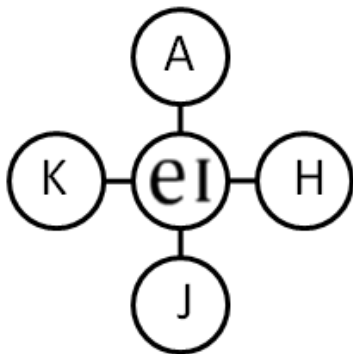

Alpha, Bravo, Charlie, Delta, Echo, Foxtrot, Golf, Hotel, India, Juliet, Kilo, Lima, Mike, November, Oscar, Papa, Quebec, Romeo, Sierra, Tango, Uniform, Victor, Whiskey, X-ray, Yankee, Zulu.

### Possible Answers:

B for...BIRMINGHAM  
 R for...READING  
 I for...INVERNESS  
 T for...TOTTENHAM  
 A for...ABERDEEN  
 I for...IPSWICH  
 N for...NOTTINGHAM

A for...ALABAMA  
 M for...MAINE  
 E for...EL PASO  
 R for...RHODE ISLAND  
 I for...IOWA  
 C for...CALIFORNIA  
 A for...ARKANSAS